

For 2" Optics

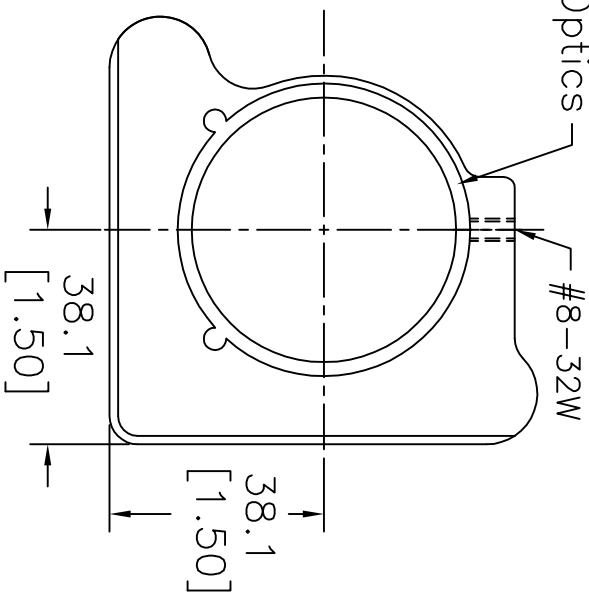

FOR T=8.5[0.33]

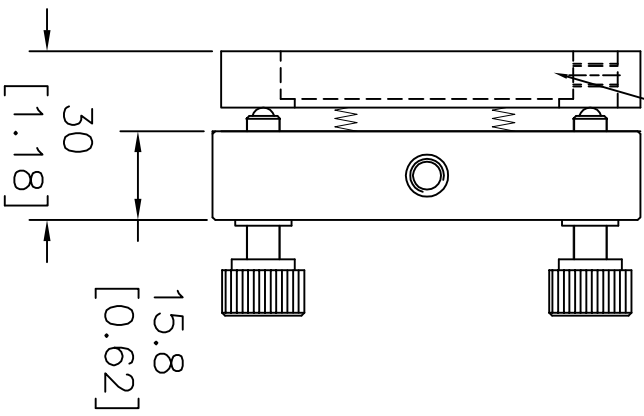

TMSO-2L

